

7000 SERIES

Designed by Clearview to meet the demands of consumers, architects and project consultants. The 7000 Series introduces a unique combination of PVC and POLYURETHANE thermal break in both the frame and sash components.



CLEARVIEW

PATIO DOORS

Clearly The Right Choice

7000 Series Patio Door Design Features

The 7000 Series is designed with a unique combination of a PVC and POLYURETHANE thermal break which allows many benefits. The combination of this thermal break technology provides our customers with colour and finish flexibility like never before in addition providing quick turnaround with reduced production lead times. The 7000 Series like its predecessor the 5000 Series Thermo-Plus, will provide excellent thermal performance and trouble free operation.

Similarly, the 7000 Series virtually eliminates door condensation⁽¹⁾, lowers heating and air conditioning costs. Add low E and argon thermal glass and consumers will find further comfort and benefit with the 7000 Series. The strength and rigidity of thermally broken aluminum framing resists greater wind loads and provides long term reliable service.

Customize your 7000 Series doors by adding decorative Locking Mechanisms, V-Groove glass, Contour Grille Bars to mention only some of the specialty options available from Clearview.

Meet and exceeds the Canadian Building Code Standards, performed in accordance with CAN/CGSB-82.1-M89.

(1) Condensation is significantly related to interior humidity level.



7000 Series Door, Integrated in Aluminum Window Wall System, adaptable to various window designs.

Optional - HC40



The HC40 door tested to AAMA/NWDA 101/I.S.2-97 to meet stringent wind loads. Heavy duty interlock rail system will withstand a wind load of 40 psf.

Standard Features:

- A unique thermal break system resulting in reduced heat transfer and incidence of condensation at higher humidity levels.
- High strength 6063-T6 aluminum prevents warping, twisting, and bowing.
- Full perimeter, double weather-stripping nearly eliminates water and air infiltration.
- Engineered sill design construction prevents water overflow at pressures of up to 500 Pa (10 psf).
- Aluminum screen with fiberglass mesh, and four adjustable rollers.
- Tempered safety glass.
- Two tandem steel rollers provide years of smooth operation.

Decorative Grill Bar / Spacer Bar Options

Clearview Industries offers a variety of decorative grill bar options. Shown below are some of the most popular design patterns. Custom designs may be available depending on availability and order.

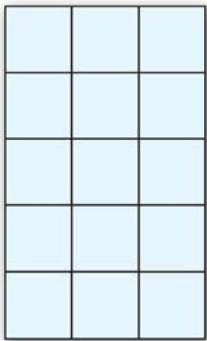

3 x 5 Colonial
(Standard Pattern)

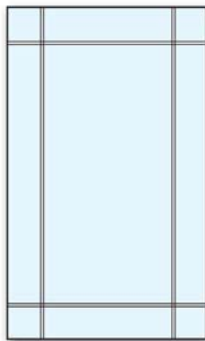

3 x 5 Prairie



Decorative grill bar options

Available spacers:



Aluminum Spacer



White Warm Edge Spacer



Grey Warm Edge Spacer



Intercept Spacer

Door Handles / Security Lock Systems / Door Frame Colours

Clearview Industries offers a variety of door handles and security lock systems to choose from. Shown below are the standard door handles and security locks available with the 7000 series.



White Surface Mount
(standard)



Black Nickel Mortise Lock
(optional)



Brushed Chrome Mortise
Handle (optional)



Brass Mortise Lock with Key
(optional)



Mortise Lock System
(optional)

Lock and security system options:

Security lock options.

- Security Bar
- Foot Lock
- Key Locks
- Locks are available in various finishes.

Please inquire with your sales agent.



Foot lock



Security bar

Colours (colours are approximate, variations may occur)
(custom colours are available)

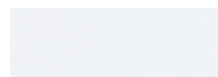

White K1285



Hickory K31202



Chocolate Brown
K72204



Cream K31029



Sandalwood K30618



Commercial Brown
K70634



Light Bronze Metallic
K70632



Clear Anodized



Flat Black K90212

7000 series top view

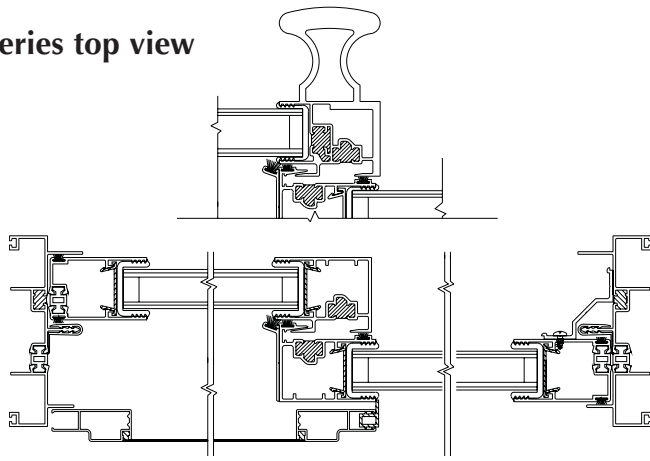

Performance Ratings:

	STD	HP	HP+	HC40
Air Infiltration:	A3	A3	A3	0.14 cfm/ft ²
Water Infiltration:	B2	B4	B5	290 Pa (6 psf)
Windload Resistance:	C3	C3	C3	40/60 psf
Ease of Operation:	E1	E1	E1	Pass
Forced Entry:	F2	F2	F2	F10
Temperature Index:	145	145		145

7000 series technical specifications:

7000 Series (Frame depth 4 1/2", comes with screen)

SIZE	Frame Size (in.)		Exterior View	Rough Opening (in.)		
	Width x Height B2	Height B4 B5		Width x Height B2	Height B4	B5
5068	59 1/2 x 79 5/8	80 1/4 81	XO or OX	60 x 80	80 5/8	81 3/8
6068	71 1/2 x 79 5/8	80 1/4 81	XO or OX	72 x 80	80 5/8	81 3/8
8068	95 5/8 x 79 5/8	80 1/4 81	XO or OX	96 x 80	80 5/8	81 3/8
9068	107 x 79 5/8	80 1/4 81	OXO	107 1/2 x 80	80 5/8	81 3/8
9068	105 x 79 5/8	80 1/4 81	XOO or OOX	105 1/2 x 80	80 5/8	81 3/8
10068	117 7/8 x 79 5/8	80 1/4 81	OXXO	118 1/2 x 80	80 5/8	81 3/8
12068	143 x 79 5/8	80 1/4 81	OXO	143 1/2 x 80	80 5/8	81 3/8
12068	141 x 79 5/8	80 1/4 81	XOO or OOX	141 1/2 x 80	80 5/8	81 3/8
12068	141 7/8 x 79 5/8	80 1/4 81	OXXO	142 1/2 x 80	80 5/8	81 3/8
12068	189 7/8 x 79 5/8	80 1/4 81	OXXO	142 1/2 x 80	80 5/8	81 3/8

Configuration: X = Operator, O = Fixed

Standard Screen Sizes (in.)

(Custom screens available)

30 1/8 x 77 1/8	5' door
36 1/8 x 77 1/8	6' door
48 1/8 x 77 1/8	8' door

Standard Glass Sizes (in.)

26 1/4 x 72 7/8	5' door
32 1/4 x 72 7/8	6' door
44 1/4 x 72 7/8	8' door

Grille Bars

- Alum Flat
- Alum Contour
- Brass / Pewter / White / Pencil Bar



High Quality Extruded aluminum threshold designed for high water penetration performance with a 6 degree slope. A double polyurethane thermal break provides maximum thermal performance
B2 Rating - 200 Pa (4 psf)

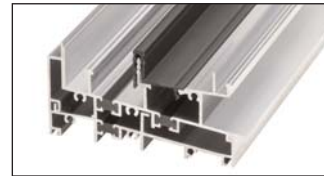

Unique designed sill with a lower level chamber improves water ex-filtration resulting in higher water penetration.
B4 Rating - 400 Pa (8 psf)

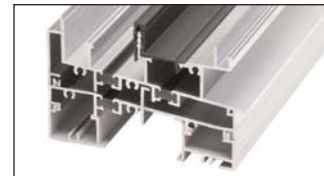

For increased water penetration requirements an additional channel may be added.
B5 Rating - 500 Pa (10 psf)

Door slide system diagram (refer to chart above for dimensions)

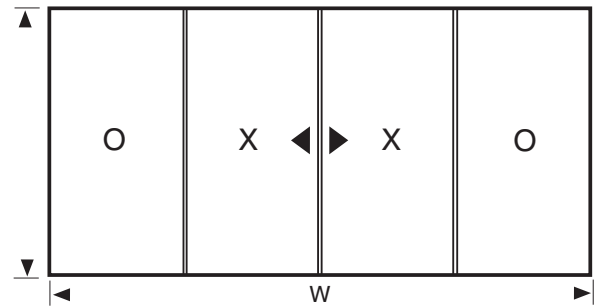
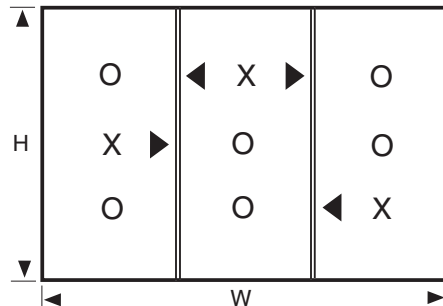
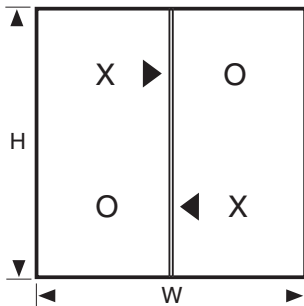

Notice: Due to Clearview's continuous product development, specifications are subject to change without notice. Please contact an authorized dealer or Clearview Industries Ltd. to confirm the most recent specifications. "Intercept" is a Registered Trademark of PPG Industries.

Authorized Distributor:

10 Year Limited Warranty on Insulating Glass Units.

10 Year Limited Warranty on Vinyl Components.

2 Year Limited Warranty on Hardware.

CLEARVIEW

Member: BILD, CRVA, NFRC

www.clearview.on.ca

e-mail: sales@clearview.on.ca